

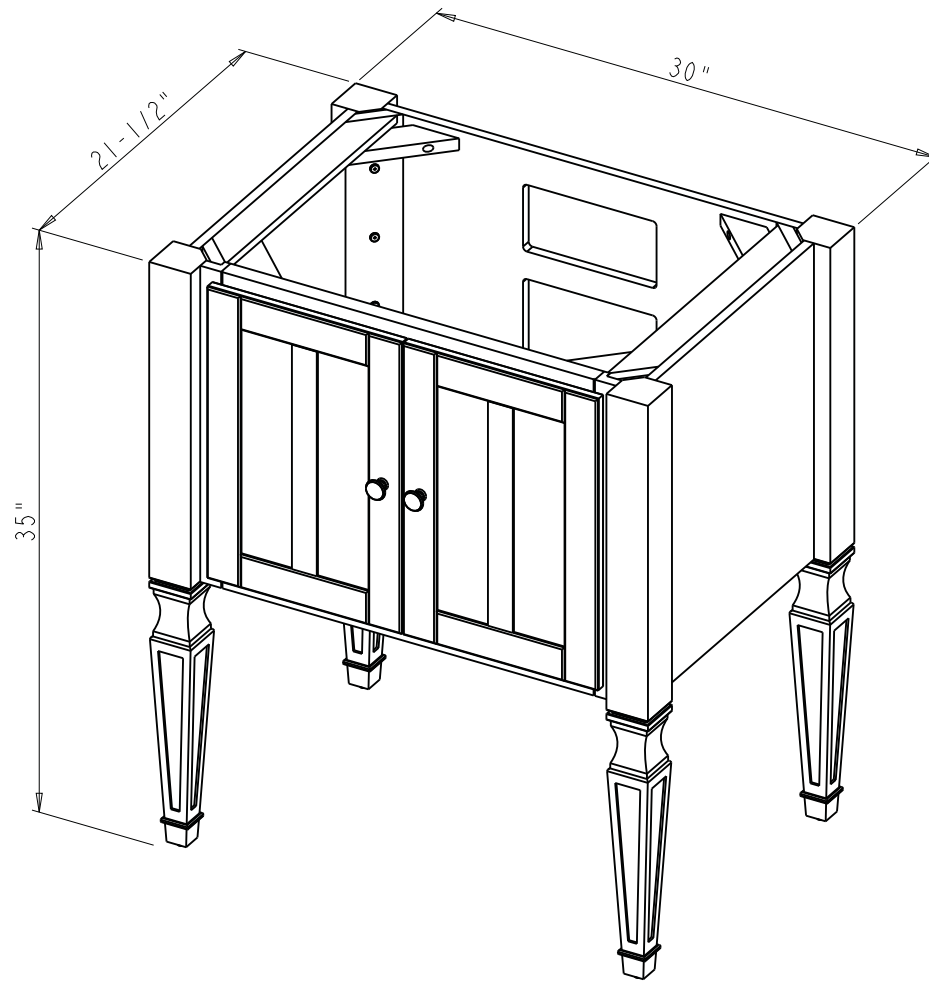

Specification:

1. Material: MDF and Birch
2. Finish: See Table
3. Hardware: See Table
4. Hinge: 7390-2C (4 Sets)
5. The tolerance is +/- 1/8"

Item number	Finish	Deco Hardware	
		Item number	Qty
VN2JEN-30-BL-NT	Blue	3910SBZ	2
VN2JEN-30-WH-NT	White	3915SN	2
VN2JEN-30-BK-NT	Black	3915SN	2
VN2JEN-30-GR-NT	Grey	3915SN	2

 PROPRIETARY AND CONFIDENTIAL THE INFORMATION CONTAINED IN THIS DRAWING IS THE SOLE PROPERTY OF HARDWARE RESOURCES INC. ANY REPRODUCTION IN PART OR AS A WHOLE WITHOUT THE WRITTEN PERMISSION OF HARDWARE RESOURCES INC. IS PROHIBITED.	ITEM#: VN2JEN-30	MATERIAL:	
	FINISH:	WEIGHT: 9	
	TOLERANCE UNLESS OTHERWISE SPECIFIED: X ±0.20 X.X ±0.10 X.XX ±0.05 ANGULAR: ±0.5°	UNITS: DRAWN BY: <i>Hugo.cai</i>	DATE: Jun-01-20
	DO NOT SCALE DRAWING	APPROVED BY:	DATE:
	SHEET:	REVISION:	
	RELEASE LEVEL:		



	ITEM#: VN2JEN-30		MATERIAL:	
	FINISH:		WEIGHT: 9	
<p>PROPRIETARY AND CONFIDENTIAL</p> <p>THE INFORMATION CONTAINED IN THIS DRAWING IS THE SOLE PROPERTY OF HARDWARE RESOURCES INC. ANY REPRODUCTION IN PART OR AS A WHOLE WITHOUT THE WRITTEN PERMISSION OF HARDWARE RESOURCES INC. IS PROHIBITED.</p>	PROJECTION 		DATE: Jun-01-20	
	TOLERANCE UNLESS OTHERWISE SPECIFIED:	UNITS:	DRAWN BY: <i>Hugo.cai</i>	DATE:
	X ±0.20	SIZE:	APPROVED BY:	DATE:
	X.X ±0.10 X.XX ±0.05 ANGULAR: ±0.5°	SHEET:	RELEASE LEVEL:	REVISION:
DO NOT SCALE DRAWING				

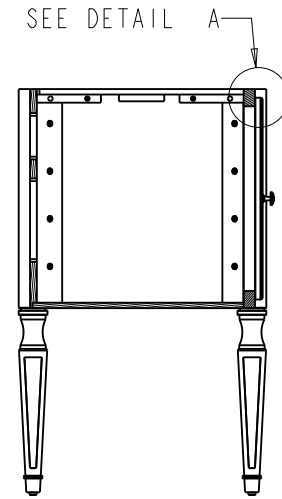
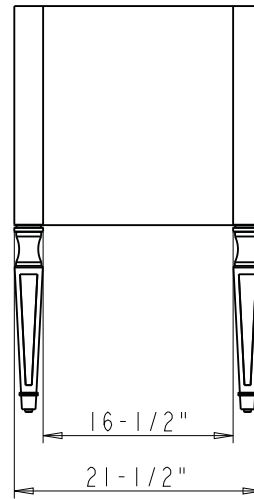
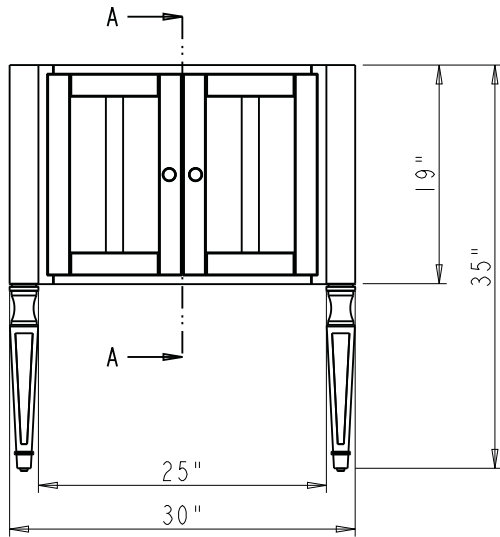

SECTION A-A

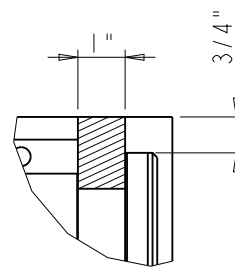
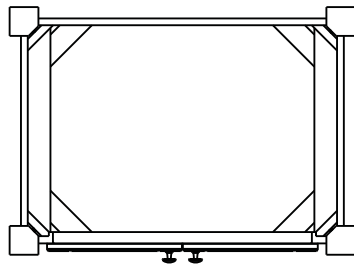

DETAIL A
SCALE 1:4

<p>hardware resources</p> <p>PROPRIETARY AND CONFIDENTIAL</p> <p>THE INFORMATION CONTAINED IN THIS DRAWING IS THE SOLE PROPERTY OF HARDWARE RESOURCES INC. ANY REPRODUCTION IN PART OR AS A WHOLE WITHOUT THE WRITTEN PERMISSION OF HARDWARE RESOURCES INC. IS PROHIBITED.</p>	ITEM:	VN2JEN-30	MATERIAL:
	FINISH:		WEIGHT:
	UNITS:		DATE:
	PROJECTION:		9
TOLERANCE UNLESS OTHERWISE SPECIFIED:	X ±0.20	SIZE:	APPROVED BY:
SIZE:	X.X ±0.10	SHEET:	RELEASE LEVEL:
ANGULAR: ±0.5°	X.XX ±0.05	DO NOT SCALE DRAWING	REVISION: