





Specification:

1. Material: MDF
2. Finish: See Table
3. Hardware: See Table
4. Hinge: 700.0536.25 + 600.3458.65 (4 set)
5. Slider: 303-300-18 (8 SETS)
6. The tolerance is +/- 1/8"

Item number	Finish	Deco Hardware	
		Item number	Qty
VN2DOU-48-BK-NT	Black	944SN	10
VN2DOU-48-BL-NT	Blue	944SBZ	10
VN2DOU-48-WH-NT	White	944MB	10

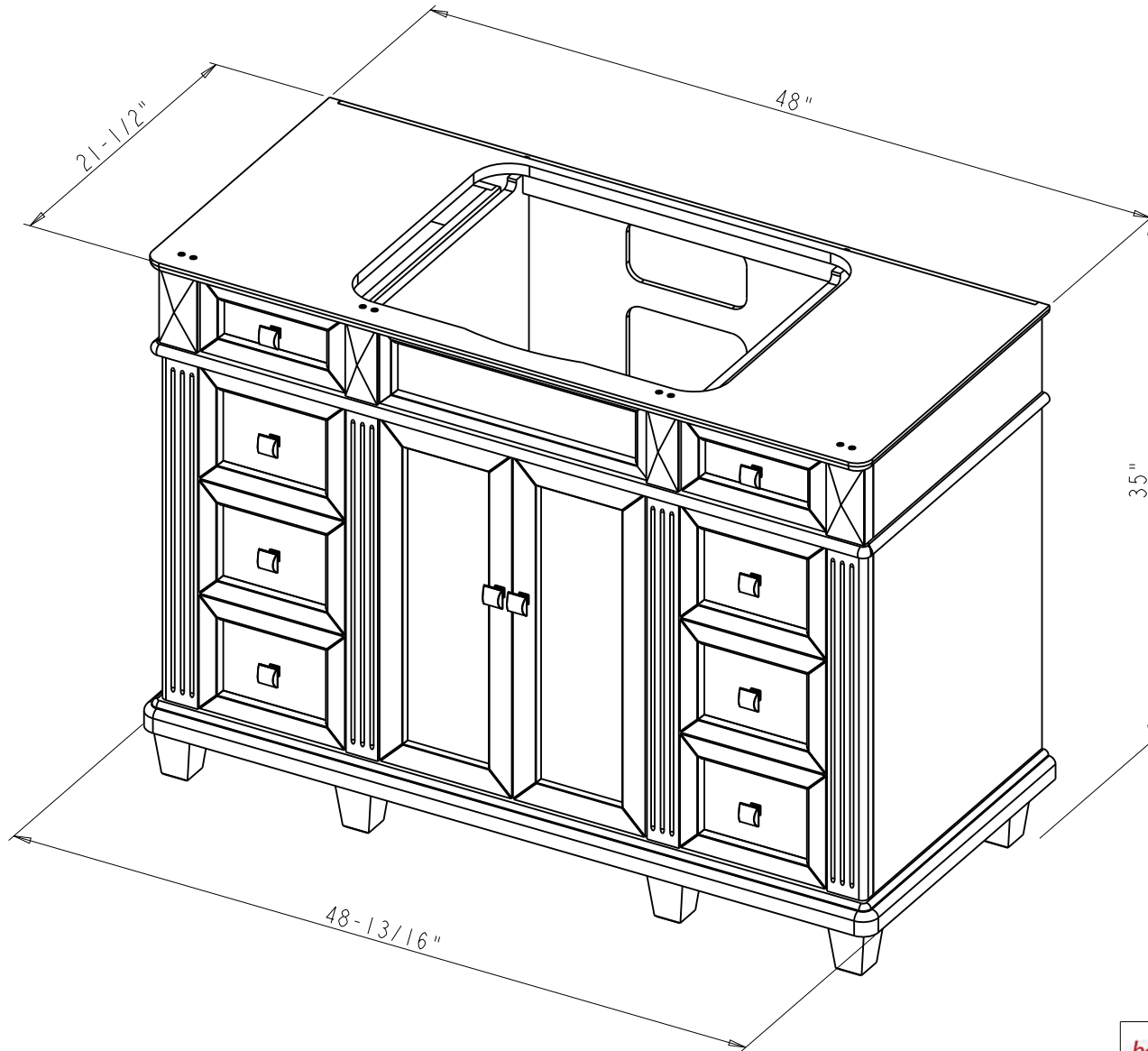
 PROPRIETARY AND CONFIDENTIAL THE INFORMATION CONTAINED IN THIS DRAWING IS THE SOLE PROPERTY OF HARDWARE RESOURCES INC. ANY REPRODUCTION IN PART OR AS A WHOLE WITHOUT THE WRITTEN PERMISSION OF HARDWARE RESOURCES INC. IS PROHIBITED. DO NOT SCALE DRAWING	ITEM:	VN2DOU-48		MATERIAL:	
	FINISH:			WEIGHT:	9
				PROJECTION	
	TOLERANCE UNLESS OTHERWISE SPECIFIED:	UNITS:	DRAWN BY:	DATE:	
X ±0.20		<i>Hugo.cai</i>	Mar-11-20		
X.X ±0.10	SIZE:	APPROVED BY:	DATE:		
X.XX ±0.05	SHEET:	RELEASE LEVEL:	REVISION:		
ANGULAR: ±0.5°					



 <p>PROPRIETARY AND CONFIDENTIAL</p> <p>THE INFORMATION CONTAINED IN THIS DRAWING IS THE SOLE PROPERTY OF HARDWARE RESOURCES INC. ANY REPRODUCTION IN PART OR AS A WHOLE WITHOUT THE WRITTEN PERMISSION OF HARDWARE RESOURCES INC. IS PROHIBITED.</p> <p>DO NOT SCALE DRAWING</p>	ITEM:	VN2DOU - 48	MATERIAL:		
	FINISH:		WEIGHT:	9	
	TOLERANCE UNLESS OTHERWISE SPECIFIED:		UNITS:	DRAWN BY:	DATE:
	X ±0.20 X.X ±0.10 X.XX ±0.05 ANGULAR: ±0.5°		SIZE:	APPROVED BY:	DATE:
		SHEET:	RELEASE LEVEL:	REVISION:	



Hugo.cai Mar - 11 - 20

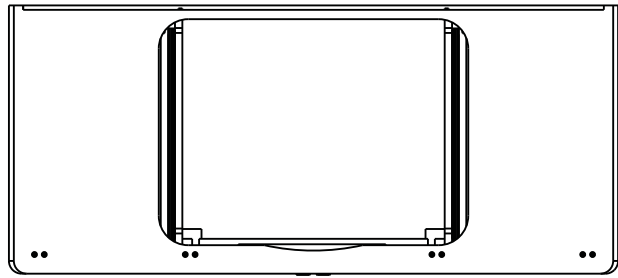
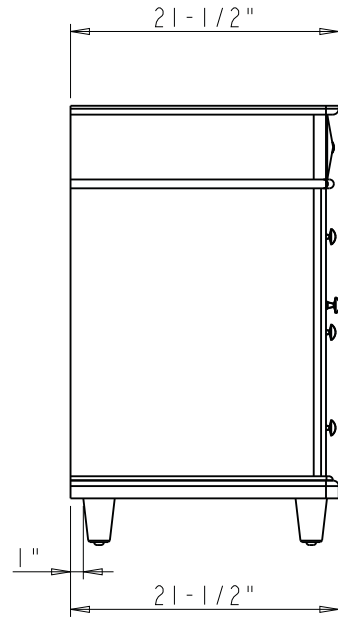
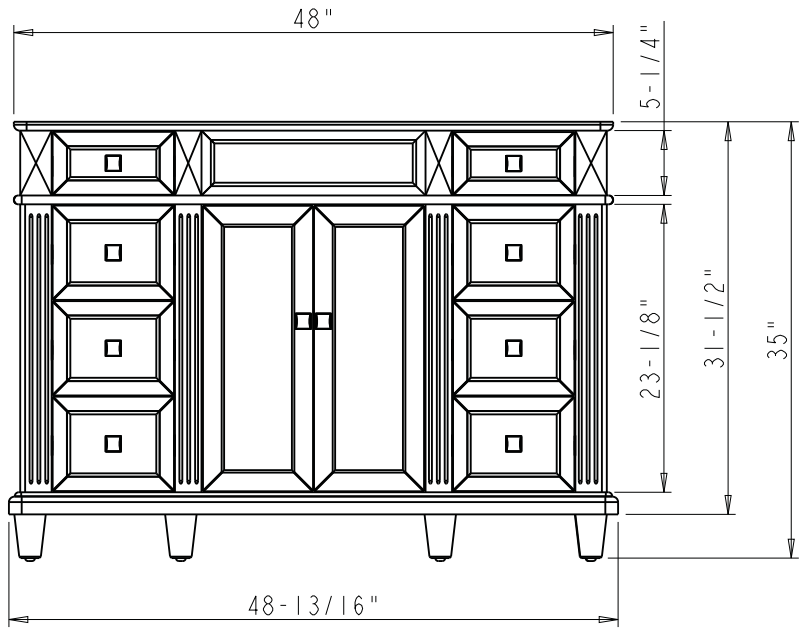

	ITEM#: VN2DOU-48		MATERIAL:	
	FINISH:		WEIGHT: 9	
<p>PROPRIETARY AND CONFIDENTIAL</p> <p>THE INFORMATION CONTAINED IN THIS DRAWING IS THE SOLE PROPERTY OF HARDWARE RESOURCES INC. ANY REPRODUCTION IN PART OR AS A WHOLE WITHOUT THE WRITTEN PERMISSION OF HARDWARE RESOURCES INC. IS PROHIBITED.</p> <p>DO NOT SCALE DRAWING</p>	UNITS:		DRAWN BY:	DATE:
	TOLERANCE UNLESS OTHERWISE SPECIFIED:		APPROVED BY:	
	SIZE:		RELEASE LEVEL:	
	SHEET:		REVISION:	



Mar-11-20