

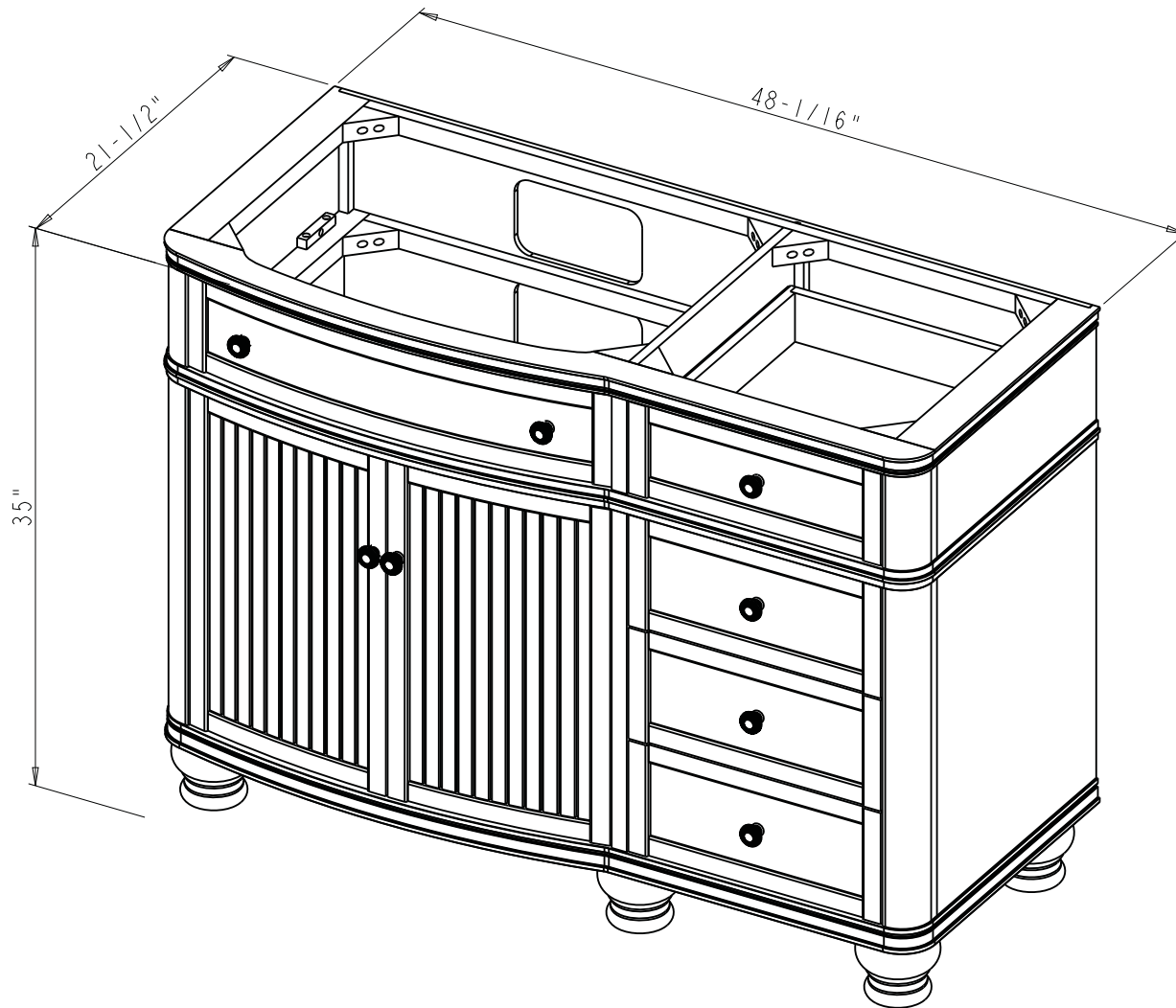

Specification:

1. Material: MDF
2. Finish: SEE TABLE
3. Hardware: SEE TABLE
4. Hinge: SEE TABLE
5. Slides: 303-300-16 (4 sets)
6. Shelf Supports (4 pcs)
7. Doormagnet (2 sets)
8. The bowl is offset to the left
9. The tolerance is +/- 1/8"



Item number	Finish	Deco Hardware		Hinge		
		Item number	Qty	Item number	Finish	Qty
VN-COM-48-WA-NT	Walnut	I37ABM-D	8	Shutter Hinge	AB	4 pcs
VN-COM-48-WH-NT	White	I37SN	8	Shutter Hinge	BN	4 pcs

<p>hardware resources</p> <p><small>PROPRIETARY AND CONFIDENTIAL</small></p> <p><small>THE INFORMATION CONTAINED IN THIS DRAWING IS THE SOLE PROPERTY OF HARDWARE RESOURCES INC. ANY REPRODUCTION IN PART OR AS A WHOLE WITHOUT THE WRITTEN PERMISSION OF HARDWARE RESOURCES INC. IS PROHIBITED.</small></p> <p><small>DO NOT SCALE DRAWING</small></p>	ITEM#: VN2COM-48	MATERIAL:	
	FINISH:	WEIGHT: 9	
	TOLERANCE UNLESS OTHERWISE SPECIFIED: X ±0.20 X.X ±0.10 X.XX ±0.05 ANGULAR: ±0.5°	UNITS:	DATE: Aug-06-19
	APPROVED BY:	RELEASE LEVEL:	REVISION:

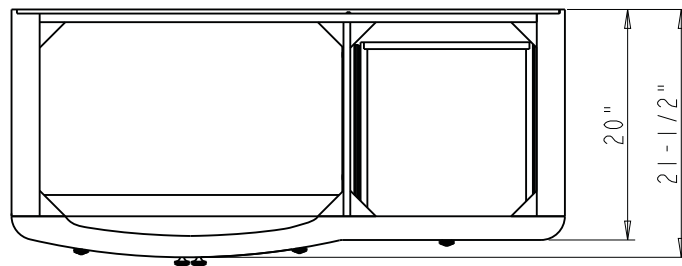
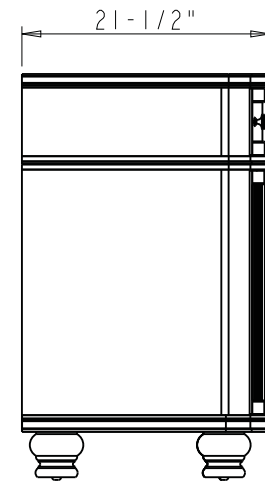
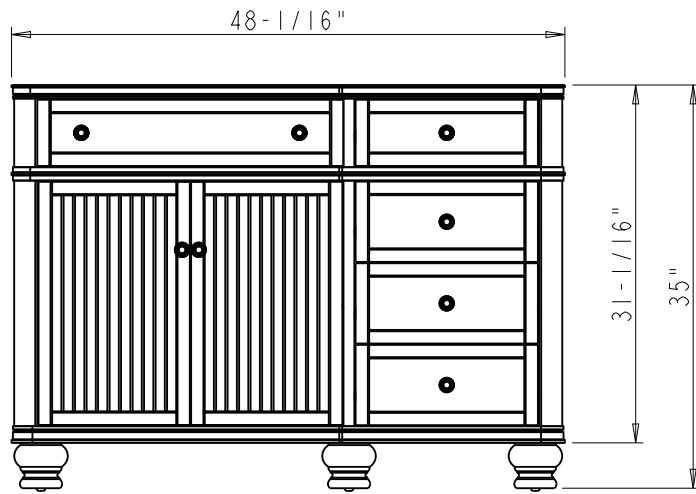

 PROPRIETARY AND CONFIDENTIAL THE INFORMATION CONTAINED IN THIS DRAWING IS THE SOLE PROPERTY OF HARDWARE RESOURCES INC. ANY REPRODUCTION IN PART OR AS A WHOLE WITHOUT THE WRITTEN PERMISSION OF HARDWARE RESOURCES INC. IS PROHIBITED.	ITEM#: VN2COM-48		MATERIAL:		
	FINISH:		WEIGHT: 9		
	TOLERANCE UNLESS OTHERWISE SPECIFIED: X ±0.20 X.X ±0.10 X.XX ±0.05 ANGULAR: ±0.5°		UNITS:	DRAWN BY: <i>Hugo.cai</i>	DATE: Aug-07-20
	DO NOT SCALE DRAWING	SIZE:	APPROVED BY:	DATE:	
	SHEET:	RELEASE LEVEL:	REVISION:		



 <p>PROPRIETARY AND CONFIDENTIAL</p> <p>THE INFORMATION CONTAINED IN THIS DRAWING IS THE SOLE PROPERTY OF HARDWARE RESOURCES INC. ANY REPRODUCTION IN PART OR AS A WHOLE WITHOUT THE WRITTEN PERMISSION OF HARDWARE RESOURCES INC. IS PROHIBITED.</p> <p>DO NOT SCALE DRAWING</p>	ITEM#: VN2COM-48	MATERIAL:	
	FINISH:	WEIGHT: 9	
	TOLERANCE UNLESS OTHERWISE SPECIFIED: X ±0.20 X.X ±0.10 X.XX ±0.05 ANGULAR: ±0.5°	PROJECTION 	DATE: Aug-07-20
	UNITS:	DRAWN BY: <i>Hugo.cai</i>	DATE:
SIZE:	APPROVED BY:	DATE:	
SHEET:	RELEASE LEVEL:	REVISION:	