

Specification:

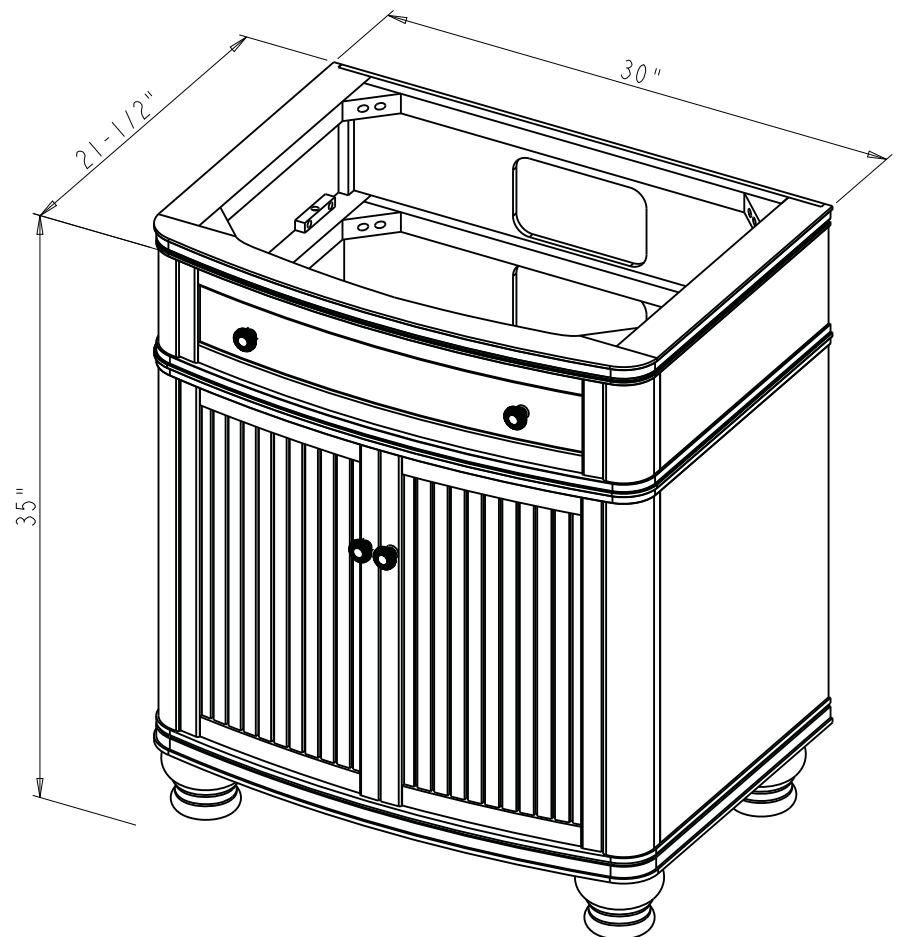

1. Material: MDF
2. Finish: SEE TABLE
3. Hardware: SEE TABLE
4. Hinge: SEE TABLE
5. Shelf Supports (4 pcs)
6. Doormagnet (2 sets)
7. The tolerance is +/- 1/8"

Item number	Finish	Deco Hardware		Hinge		
		Item number	Qty	Item number	Finish	Qty
VN2COM-30-WA-NT	Walnut	I37ABM-D	4	Shutter Hinge	AB	4 pcs
VN2COM-30-WH-NT	White	I37SN	4	Shutter Hinge	BN	4 pcs



<p>hardware resources</p> <p><small>PROPRIETARY AND CONFIDENTIAL</small></p> <p><small>THE INFORMATION CONTAINED IN THIS DRAWING IS THE SOLE PROPERTY OF HARDWARE RESOURCES INC. ANY REPRODUCTION IN PART OR AS A WHOLE WITHOUT THE WRITTEN PERMISSION OF HARDWARE RESOURCES INC. IS PROHIBITED.</small></p> <p><small>DO NOT SCALE DRAWING</small></p>	ITEM:	VN2COM-30		MATERIAL:		
	FINISH:			WEIGHT:	9	
	TOLERANCE UNLESS OTHERWISE SPECIFIED:	UNITS:	DRAWN BY:	DATE:		
	X ±0.20 X.X ±0.10 X.XX ±0.05 ANGULAR: ±0.5°	SIZE:	APPROVED BY:	DATE:		
	SHEET:	RELEASE LEVEL:	REVISION:			

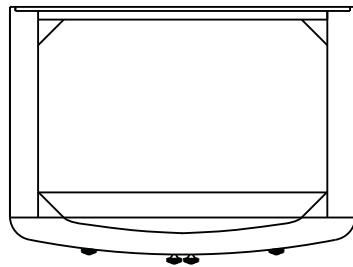
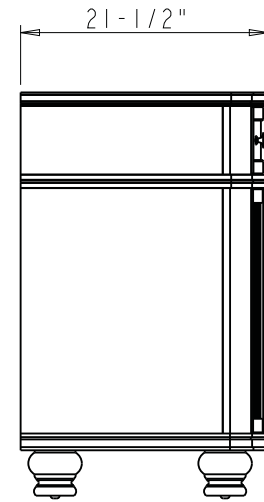
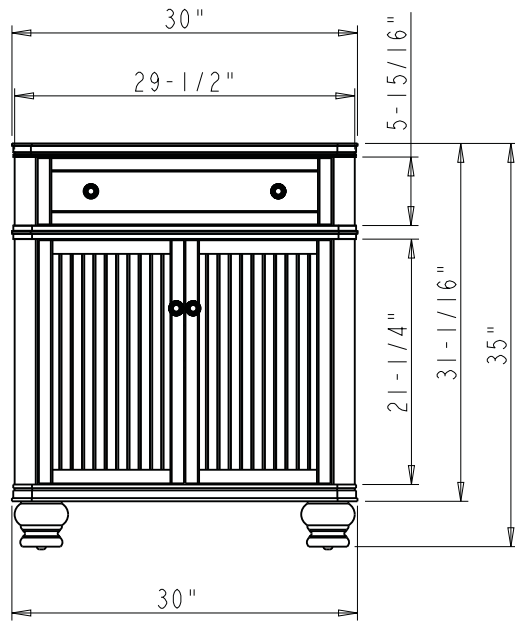

SCALE 1:10

 PROPRIETARY AND CONFIDENTIAL THE INFORMATION CONTAINED IN THIS DRAWING IS THE SOLE PROPERTY OF HARDWARE RESOURCES INC. ANY REPRODUCTION IN PART OR AS A WHOLE WITHOUT THE WRITTEN PERMISSION OF HARDWARE RESOURCES INC. IS PROHIBITED.	ITEM#: VN2COM-30		MATERIAL:	
			WEIGHT:	
			9	
			PROJECTION 	
TOLERANCE UNLESS OTHERWISE SPECIFIED:	UNITS:	DRAWN BY: <i>Hugo.cai</i>		DATE: Aug-10-20
X ±0.20		APPROVED BY:		DATE:
X.X ±0.10	SIZE:	RELEASE LEVEL:		REVISION:
X.XX ±0.05	SHEET:			
ANGULAR: ±0.5°	DO NOT SCALE DRAWING			



 <p>PROPRIETARY AND CONFIDENTIAL</p> <p>THE INFORMATION CONTAINED IN THIS DRAWING IS THE SOLE PROPERTY OF HARDWARE RESOURCES INC. ANY REPRODUCTION IN PART OR AS A WHOLE WITHOUT THE WRITTEN PERMISSION OF HARDWARE RESOURCES INC. IS PROHIBITED.</p> <p>DO NOT SCALE DRAWING</p>	ITEM:	VN2COM-30		MATERIAL:
	FINISH:			WEIGHT:
				PROJECTION
				
TOLERANCE UNLESS OTHERWISE SPECIFIED:	UNITS:	DRAWN BY:	DATE:	
X ±0.20		<i>Hugo.cai</i>	Aug-10-20	
X.X ±0.10	SIZE:	APPROVED BY:	DATE:	
X.XX ±0.05				
ANGULAR: ±0.5°	SHEET:	RELEASE LEVEL:	REVISION:	