

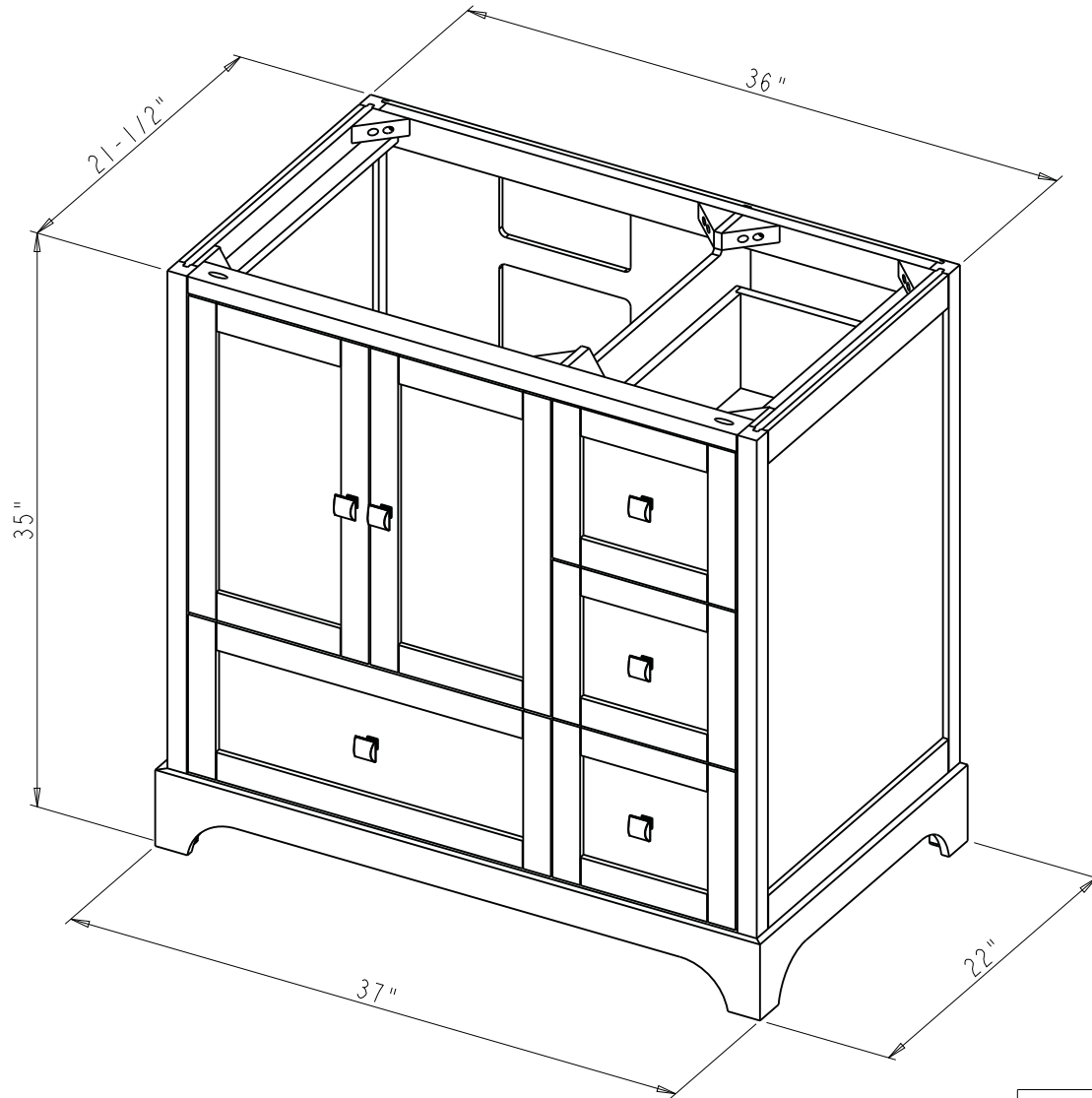

Specification:

1. Material: MDF
2. Finish: See Table
3. Hardware: See Table
4. Hinge: 700.0535.25 + 600.1234.05 (4 Sets)
5. Slide: 303-300-18 (4 set)
6. The bowl is offset to the lift
7. The tolerance is +/- 1/8"

Item number	Finish	Deco Hardware	
		Item number	Qty
VN2ADD-36-GR-NT	Grey	944SN	6
VN2ADD-36-WH-NT	White	944MB	6

 PROPRIETARY AND CONFIDENTIAL THE INFORMATION CONTAINED IN THIS DRAWING IS THE SOLE PROPERTY OF HARDWARE RESOURCES INC. ANY REPRODUCTION IN PART OR AS A WHOLE WITHOUT THE WRITTEN PERMISSION OF HARDWARE RESOURCES INC. IS PROHIBITED.	ITEM:	VN2ADD-36		MATERIAL:	
	FINISH:			WEIGHT:	
	TOLERANCE UNLESS OTHERWISE SPECIFIED:			UNITS:	DATE:
	DO NOT SCALE DRAWING			RELEASE LEVEL:	REVISION:
SIZE: X ±0.20 X.X ±0.10 X.XX ±0.05 ANGULAR: ±0.5°		APPROVED BY:	DATE: Aug-25-20		
DRAWN BY:		Hugo.cai		DATE:	



 <p>hardware resources</p> <p>PROPRIETARY AND CONFIDENTIAL</p> <p>THE INFORMATION CONTAINED IN THIS DRAWING IS THE SOLE PROPERTY OF HARDWARE RESOURCES INC. ANY REPRODUCTION IN PART OR AS A WHOLE WITHOUT THE WRITTEN PERMISSION OF HARDWARE RESOURCES INC. IS PROHIBITED.</p> <p>DO NOT SCALE DRAWING</p>	ITEM#: VN2ADD-36		MATERIAL:		
	FINISH:		WEIGHT: 9		
	TOLERANCE UNLESS OTHERWISE SPECIFIED: X ±0.20 X.X ±0.10 X.XX ±0.05 ANGULAR: ±0.5°		UNITS:	DRAWN BY: <i>Hugo.cai</i>	DATE: Aug-25-20
	SHEET:		APPROVED BY:	DATE:	REVISION:
PROJECTION 		RELEASE LEVEL:			

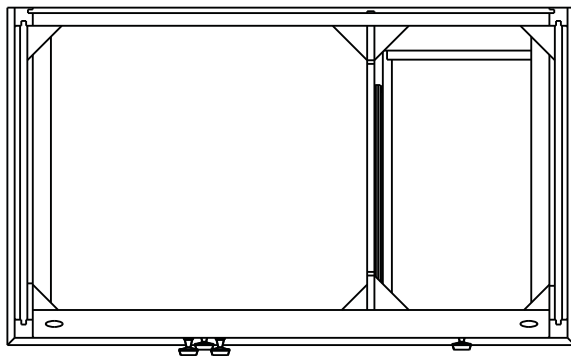
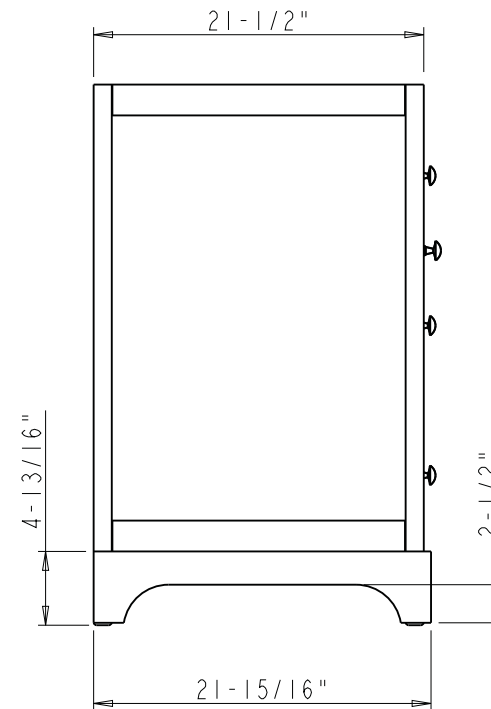
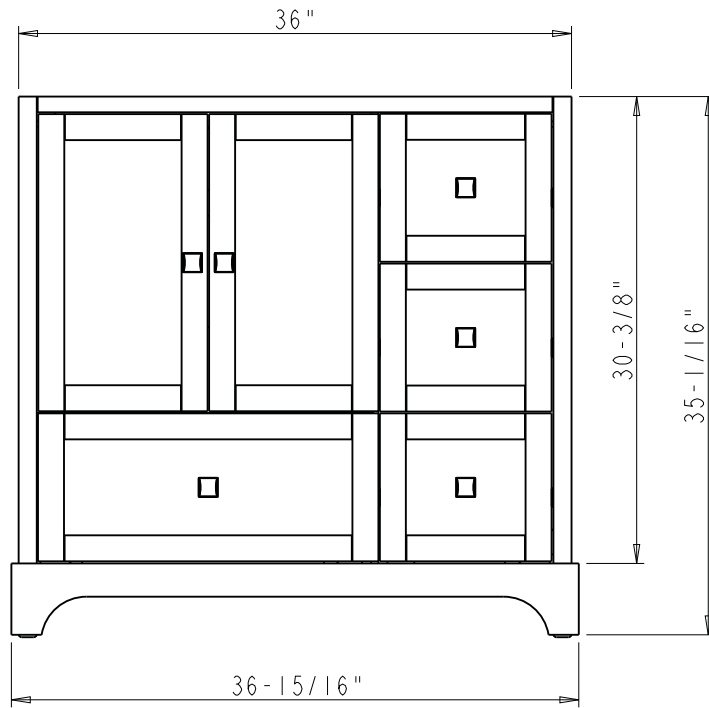

<p>hardware resources</p> <p>PROPRIETARY AND CONFIDENTIAL</p> <p>THE INFORMATION CONTAINED IN THIS DRAWING IS THE SOLE PROPERTY OF HARDWARE RESOURCES INC. ANY REPRODUCTION IN PART OR AS A WHOLE WITHOUT THE WRITTEN PERMISSION OF HARDWARE RESOURCES INC. IS PROHIBITED.</p> <p>DO NOT SCALE DRAWING</p>	ITEM: VN2ADD-36		MATERIAL:		
	FINISH:		WEIGHT:		
	TOLERANCE UNLESS OTHERWISE SPECIFIED: X ±0.20 X.X ±0.10 X.XX ±0.05 ANGULAR: ±0.5°		UNITS:	DRAWN BY: <i>Hugo.cai</i>	DATE: Aug-25-20
	SIZE:		APPROVED BY:	DATE:	
SHEET:		RELEASE LEVEL:	REVISION:	9	