





Specification:

1. Material: MDF
2. Finish: See Table
3. Hardware: See Table
4. Hinge: 700.0537.25 + 600.1234.05 ( 4 Sets )
5. Slide: 303-300-18 ( 1 set )
6. The tolerance is +/- 1/8"

Item number	Finish	Deco Hardware	
		Item number	Qty
VN2ADD-24-GR-NT	Grey	944SN	3
VN2ADD-24-WH-NT	White	944MB	3

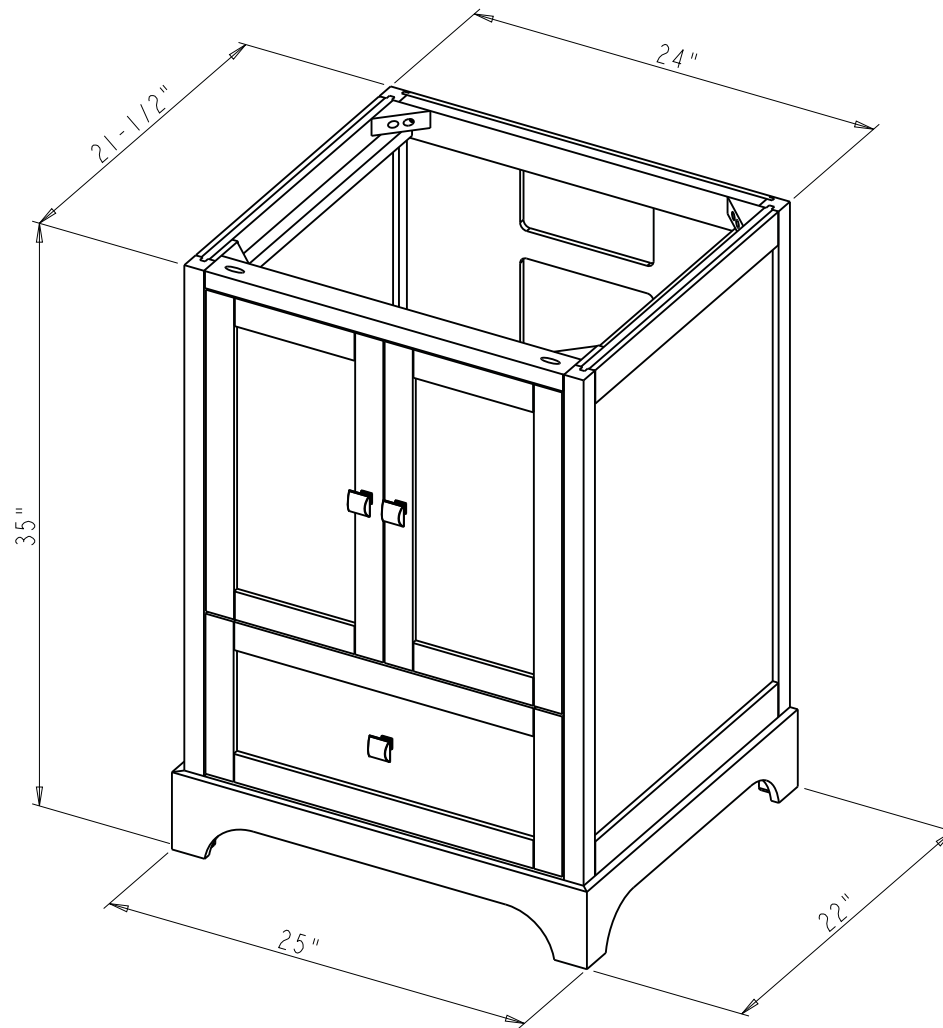
 <b>PROPRIETARY AND CONFIDENTIAL</b> THE INFORMATION CONTAINED IN THIS DRAWING IS THE SOLE PROPERTY OF HARDWARE RESOURCES INC. ANY REPRODUCTION IN PART OR AS A WHOLE WITHOUT THE WRITTEN PERMISSION OF HARDWARE RESOURCES INC. IS PROHIBITED. DO NOT SCALE DRAWING	ITEM#: VN2ADD-24	MATERIAL:
	FINISH:	WEIGHT: 9
	PROJECTION 	
	TOLERANCE UNLESS OTHERWISE SPECIFIED: X ±0.20 X.X ±0.10 X.XX ±0.05 ANGULAR: ±0.5°	UNITS: DRAWN BY: <i>Hugo.cai</i>
	APPROVED BY:	DATE:
	RELEASE LEVEL:	REVISION:



	ITEM#: VN2ADD-24		MATERIAL:	
	FINISH:		WEIGHT: 9	
<p><b>PROPRIETARY AND CONFIDENTIAL</b></p> <p>THE INFORMATION CONTAINED IN THIS DRAWING IS THE SOLE PROPERTY OF HARDWARE RESOURCES INC. ANY REPRODUCTION IN PART OR AS A WHOLE WITHOUT THE WRITTEN PERMISSION OF HARDWARE RESOURCES INC. IS PROHIBITED.</p>	PROJECTION 		DATE: Aug-25-20	
	TOLERANCE UNLESS OTHERWISE SPECIFIED:	UNITS:	DRAWN BY: Hugo.cai	DATE:
	X ±0.20	SIZE:	APPROVED BY:	DATE:
	X.X ±0.10	SHEET:	RELEASE LEVEL:	REVISION:
X.XX ±0.05	DO NOT SCALE DRAWING			
ANGULAR: ±0.5°				

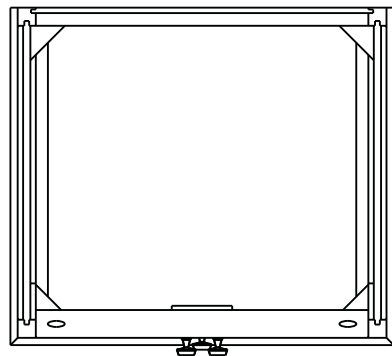
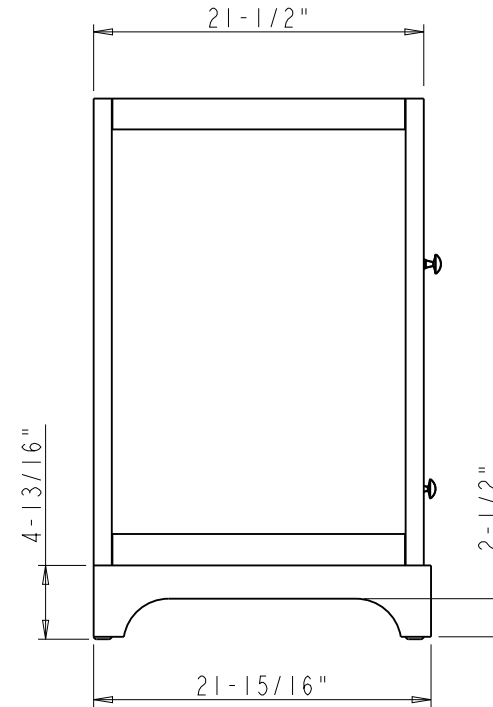
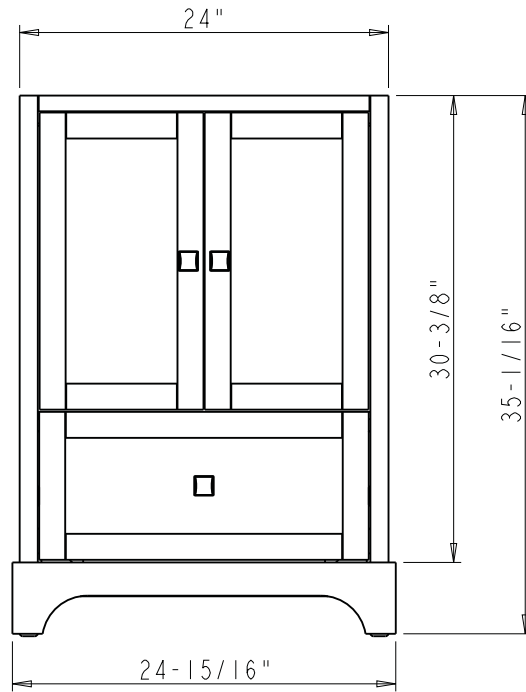

 <b>PROPRIETARY AND CONFIDENTIAL</b> THE INFORMATION CONTAINED IN THIS DRAWING IS THE SOLE PROPERTY OF HARDWARE RESOURCES INC. ANY REPRODUCTION IN PART OR AS A WHOLE WITHOUT THE WRITTEN PERMISSION OF HARDWARE RESOURCES INC. IS PROHIBITED.	ITEM#: VN2ADD-24	MATERIAL:	
	FINISH:	WEIGHT: 9	
TOLERANCE UNLESS OTHERWISE SPECIFIED: X ±0.20 X.X ±0.10 X.XX ±0.05 ANGULAR: ±0.5° DO NOT SCALE DRAWING	UNITS:	DRAWN BY: <i>Hugo.cai</i>	DATE: Aug-25-20
	SIZE:	APPROVED BY:	DATE:
	SHEET:	RELEASE LEVEL:	REVISION:
	PROJECTION 